



Owner's Manual

Original Instructions

Air Source Heat Pump Water Heater

Models:

GRS-1.5Pd/TD200ANpA-K

GRS-1.5Pd/TD270ANpA-K

Thank you for choosing this product. Please read this Owner's Manual carefully before operation and retain it for future reference.

If you have lost the Owner's Manual, please contact the local agent or visit www.gree.com or send an email to global@cn.gree.com for the electronic version.

GREE ELECTRIC APPLIANCES, INC. OF ZHUHAI

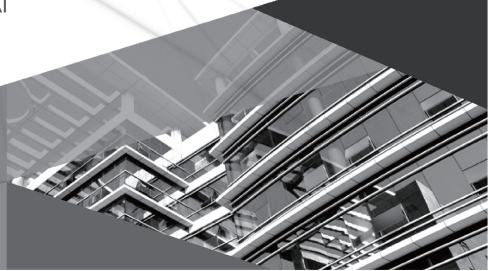

To Users

Thank you for selecting Gree product. Please read this instruction manual carefully before installing and using the product, so as to master and correctly use the product. In order to guide you to correctly install and use our product and achieve expected operating effect, we hereby instruct as below:

- (1) This appliance can be used by children aged from 8 years and above and persons with reduced physical, sensory or mental capabilities or lack of experience and knowledge if they have been given supervision or instruction concerning use of the appliance in a safe way and understand the hazards involved. Children shall not play with the appliance. Cleaning and user maintenance shall not be made by children without supervision (For EN Standard).
- (2) This appliance is not intended for use by persons (including children) with reduced physical, sensory or mental capabilities, or lack of experience and knowledge, unless they have been given supervision or instruction concerning use of the appliance by a person responsible for their safety. Children should be supervised to ensure that they do not play with the appliance (For IEC Standard).
- (3) In order to ensure reliability of product, the product may consume some power under stand-by status for maintaining normal communication of system and preheating refrigerant and lubricant. If the product is not to be used for long, cut off the power supply; please energize and preheat the unit in advance before reusing it.
- (4) Please properly select the model according to actual using environment; otherwise it may impact the using convenience.
- (5) If the product needs to be installed, moved or maintained, please contact our designated dealer or local service center for professional support. Users should not disassemble or maintain the unit by themselves, otherwise it may cause relative damage, and our company will bear no responsibilities.
- (6) All the illustrations and information in the instruction manual are only for reference. In order to make the product better, we will continuously

conduct improvement and innovation. If there is adjustment in the product, please subject to actual product.

- (7) If the supply cord is damaged, it must be replaced by the manufacturer, its service agent or similarly qualified persons in order to avoid a hazard.

Exception Clauses

Manufacturer will bear no responsibilities when personal injury or property loss is caused by the following reasons:

- (1) Damage the product due to improper use or misuse of the product;
- (2) Alter, change, maintain or use the product with other equipment without abiding by the instruction manual of manufacturer;
- (3) After verification, the defect of product is directly caused by corrosive gas;
- (4) After verification, defects are due to improper operation during transportation of product;
- (5) Operate, repair, maintain the unit without abiding by instruction manual or related regulations;
- (6) After verification, the problem or dispute is caused by the quality specification or performance of parts and components that produced by other manufacturers;
- (7) The damage is caused by natural calamities, bad using environment or force majeure.

Content

1 Safety Notices (Please be Sure to Abide)	1
2 Product Introductions	3
2.1 Working Principle and Features of Product	3
2.2 Product Control	4
2.3 Product Parameters	6
2.4 Product Performance Curves	10
2.5 Introduction of Parts	12
2.6 Accessories	12
3 Before Installation	12
3.1 Unpacking	12
3.2 Transporting	13
4 Installation of Product	13
4.1 Safety Notices for Installation, Maintenance and Relocation of Unit	13
4.2 Unit Installation Diagram	14
4.3 Structural Dimension	15
4.4 Requirements of Installation Dimension	16
4.5 Installation Requirements	16
4.6 Installation Requirements of Water System Pipeline	18
4.7 Installation Requirements for Pipeline of Wind System	19
4.8 Electrical Installation	22
4.9 Wired Controller Installation	24
5 Commissioning Operation	24
5.1 Check before Commissioning	25
5.2 Trial Operation	25
5.3 Debugging for Air Volume	26

- 6 Maintenances 26**
 - 6.1 Water Recharge, Drainage and Cleaning27
 - 6.2 Maintenance of Anode Rod27
 - 6.3 Maintenance of Safety Valve27
 - 6.4 Maintenance in Winter28
- 7 Common Phenomena 28**
- 8 Detailed Installation Instructions for Unit Fixing Belt... 30**
- 9 Detailed Maintenance Instructions for Refrigeration System 30**
 - 9.1 Safety Notices for Refrigeration System Repairation.....30
 - 9.2 Aptitude Requirement for Maintenance Man (Repairs should be done only be specialists).31
 - 9.3 Safety Preparation Work31
- 10 Troubleshooting..... 38**
- Attachment: Error information table 39**

1 Safety Notices (Please be Sure to Abide)



WARNING! If not abide strictly, it may cause severe damage to the unit or the people.



NOTE! If not abide strictly, it may cause slight or medium damage to the unit or the people.



WARNING! The R290 Refrigerant

- To realize the function of the unit, a special refrigerant circulates in the system. The used refrigerant is the fluoride R290, which is specially cleaned. The refrigerant is flammable and inodorous. Furthermore, it can lead to explosion under certain conditions.
- Compared to common refrigerants, R290 is a nonpolluting refrigerant with no harm to the ozonosphere. The influence upon the greenhouse effect is also lower. R290 has got very good thermodynamic features which lead to a really high energy efficiency. The units therefore need a less filling.
- The appliance shall be stored in a room without continuously operating ignition sources (for example: open flames, an operating gas appliance or an operating electric heater.)
- The appliance shall be stored in a well-ventilated area.
- The appliance shall be stored so as to prevent mechanical damage from occurring.
- Ducts connected to an appliance shall not contain an ignition source.
- Keep any required ventilation openings clear of obstruction.
- Do not pierce or burn.
- Be aware that refrigerants may not contain an odour.
- Do not use means to accelerate the defrosting process or to clean, other than those recommended by the manufacturer.
- Servicing shall be performed only as recommended by the manufacturer.
- Should repair be necessary, contact your nearest authorized Service Centre. Any repairs carried out by unqualified personnel may be dangerous.
- Compliance with national gas regulations shall be observed.
- Read specialist's manual.

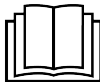

This marking indicates that this product should not be disposed with other house hold wastes throughout the EU. To prevent possible harm to the environment or human health from uncontrolled waste disposal, recycle it responsibly to promote the sustainable reuse of material resources. To return your used device, please use the return and collection systems or contact the retailer where the product was purchased. They can take this product for environmental safe recycling.



WARNING!

- This product can't be installed at corrosive, inflammable or explosive environment or the place with special requirements. Otherwise, it will affect the normal operation or shorten the service life of the unit, or even cause fire hazard or serious injury. As for above special places, please adopt special air source heat pump water heater with anti-corrosive or anti-explosion function.
- It is not allow hanging the water tank and it is forbidden to install it in the place with water spray or the low-lying place where water is easy to accumulate.
- The appliance is intended to be permanently connected to the water mains and not connected by a hose-set.
- The highest water outlet temperature is up to 70°C, so thermostatic mixer tap must be installed on the water side to avoid scalding injury.
- In order to avoid scald, please open the cold water side first when using water, and gradually adjust to the proper water temperature before use.
- Children aged from 3 to 8 years are only allowed to operate the tap connected to the unit.
- Don't operate the water heater with wet hands; during maintenance, please cut off power.
- This appliance does not have engineering installed supplementary heater. Supplementary heater is available as a component. The minimum clearance from the appliance to combustible surfaces must be at least 1.5m.
- Don't step on the top of the unit or place anything on it.
- Please keep air inlet and air outlet clean, no obstacles.
- Do not through sundries into the air ducts (If air ducts are connected). If there are sundries get into the air duct, please contact the professionals to deal with it. Do not use an extension cord.
- User cannot change power cord, power socket or ground mode without prior consent.
- Once abnormality like burning smell occurs, please cut off the power supply immediately.



NOTE!

- If the product will be used in winter (temperature may be lower than 0°C), please ensure that the unit is always powered on; if it is won't be used for a long time, please make sure to drain the water in the unit, water tank and pipes to avoid the system from cracking.
- PPR pipe is recommended for water pipe and effective thermal insulation is required.
- The unit must be installed with a safety valve (Unless specifically stated, safety valve in the following refers to pressure-relief device) as required.
- It is forbidden to install the unit and safety valve in a room where there is no floor drain. It is forbidden to block the exhaust hole of floor drain.
- Check the safety valve and residual current device (RCD) periodically.
- Model and rated value of protective tube on the main board shall subject to the silkprint label of corresponding controller or protective tube cover.
- Check water quality before installation. If necessary, add pre-filtration device to purify water quality.
- Entering cold water quality of the unit shall meet corresponding national and local standards for drinking water. The use of well water, groundwater, seawater, water treated with a water softener, etc. may shorten the service life of the unit and produce abnormal odors. Dirty sewage can cause abnormal heat exchange or corrosion of the unit, and direct use is prohibited.
- Do not replace the accessories on your own. It's recommended to conduct regular inspections and maintenance every year. Please contact our designated dealer or local service center for professional support.
- After the warranty period of the product, it's necessary to conduct maintenance or replacement for key components such as safety valve, electronic anode, heat exchanger, etc. It is not recommended to use them for a long time. Otherwise, we may not be able to bear relevant legal responsibilities for all the losses incurred.
- If you need to scrap it, please contact our authorized service center nearby.

2 Product Introductions

2.1 Working Principle and Features of Product

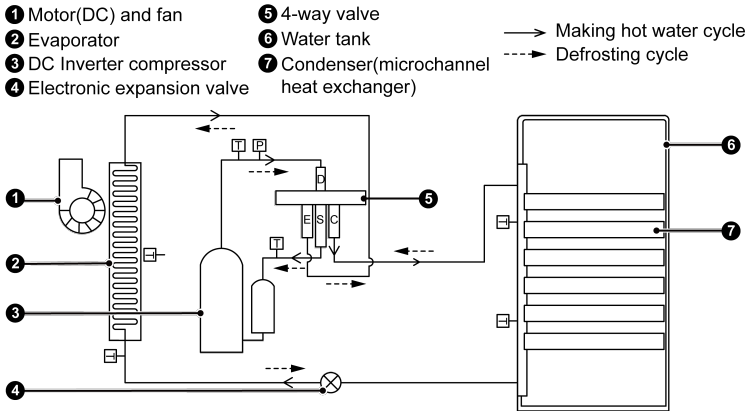

Fig. 2.1-1 Air source water heater operating principle

The heat pump principle is used by the air source heat pump water heater. When the unit normally makes hot water, the 4-way valve is powered off (D and C are connected, S and E are connected), the high-temperature and high-pressure refrigerant comes out of the compressor, enters the water tank heat exchanger (microchannel heat exchanger), condenses into high-pressure liquid, and then throttles into low-pressure gas-liquid two-phase refrigerant by the electronic expansion valve, and then enters the evaporator to absorb heat, become gaseous refrigerant, and then is inhaled by the compressor. Compressed into high temperature and high pressure gaseous refrigerant, and so repeated cycle.

When the unit defrosts, the 4-way valve is powered on (D and E are connected, S and C are connected). The evaporator of the unit is used as a condenser, and the microchannel heat exchanger is used as a evaporator), the high-temperature and high-pressure gaseous refrigerant comes out of the compressor, enters the evaporator after the 4-way valve, condenses into a high-pressure liquid, and then passes through the electronic expansion valve to throttle into a low-pressure gas-liquid two-phase refrigerant, and then enters the water tank heat exchanger. Becomes gaseous refrigerant, and then is inhaled by the compressor, compressed into high temperature and high pressure gaseous refrigerant, so repeated cycle.

Air source water heater is a new kind of high-efficiency, energy-saving and

eco-friendly product. This series of units adopt a special compressor for heat pump water heater that is resistant to high temperature and pressure; the crystal titanium blue enamel inner tank produced with advanced technology is used on the water tank side. The entire unit is equipped with multiple protections to ensure the durability of the system. The unit has various heating modes and humanized functions for selection, e.g. timer on/off.

2.2 Product Control

2.2.1 Overall product control ideas

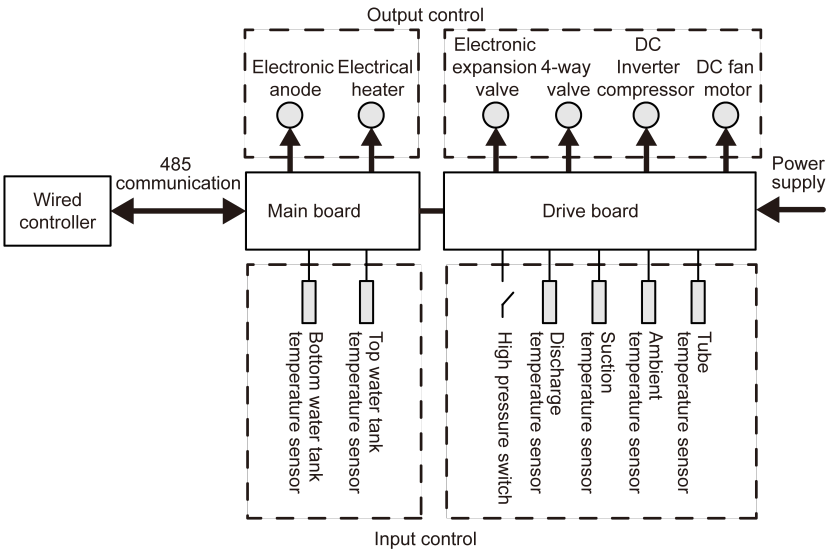

2.2.2 Control and Protection

(1) Temperature sensors

- 1) Top water tank temperature sensor, of which the resistance is 50K, used to detect the upper temperature of the water tank.
- 2) Bottom water tank temperature sensor, of which the resistance is 50K, used to detect the temperature at the lower part of the water tank.
- 3) Ambient temperature sensor, of which the resistance is 15K, used to detect the ambient temperature (inlet air temperature).
- 4) Suction temperature sensor, of which the resistance is 20K, used to detect the temperature of the suction temperature of the compressor.
- 5) Discharge temperature sensor, of which the resistance is 50K, used to

detect the exhaust temperature of compressor.

- 6) Tube temperature sensor, of which the resistance is 20K, used to detect heat exchanger tube temperature.

(2) High pressure switch

Real-time detection the exhaust pressure of system, when the pressure reaches the protection value (3.2MPa, gauge pressure), the unit stops or does not start. When the discharge pressure is less than 2.6MPa (gauge pressure), the system automatically resumes operation. If the discharge pressure protection accumulates for three times within 120 minutes, the system cannot resume operation, and the high pressure protection fault code is displayed on the wire controller. Press the on/off button to clear the fault.

(3) High discharge temperature protection

When the gas discharge temperature is greater than or equal to 115°C, the unit stops or does not start. When the discharge temperature is less than 90°C, the system automatically resumes operation. If the above phenomenon is detected for three times within 60 minutes, the system cannot resume operation, and the high discharge protection fault code is displayed on the wire controller. If the exhaust high-temperature protection accumulates for three times within 60 minutes, press the on/off button to clear the fault.

(4) Anti-freezing function

When the unit is shut down, the system detects that the water temperature of the unit. If the water temperature is too low in the low ambient temperature; the unit will directly start for antifreeze operation.

(5) Control on DC Inverter compressor

After power is connected, start the system by the wired controller and detect the outdoor ambient temperature sensor. If the outdoor ambient temperature is not lower than -7°C and when no error is detected and start up conditions of the compressor are met, the system starts by following the hot water sequence. The frequency of the compressor will determine by the hot water demand.

(6) Control on DC fan motor

When start up conditions of the compressor is met, the system starts by following the hot water sequence. The electronic expansion valve resets and is initialized, and the fan motor starts. Then speed of the fan will determine by the

length of the ducts and hot water demand.

(7) Control on defrosting

In low temperature environment, if the defrosting condition is met, the system defrosts. After defrosting is over, the compressor and the fan start for heat up. When the cumulative operation time exceeds or equals to the preset time for defrosting, defrosting will be performed if the temperature difference between the outdoor exchanger pipe and environment temperature sensor meets the defrosting condition.

2.3 Product Parameters

2.3.1 General

Model		GRS-1.5Pd/TD200ANpA-K	GRS-1.5Pd/TD270ANpA-K
Rated volume of the tank	L	206	270
Dimensions	W×D×H	mm	668×663×1667
Net Weight (when empty)	kg	96	108
Weight (full)	kg	302	378
Heat insulation	mm	50, Polyurethane foam	
Material of the product container	—	Enameled steel	
Water tank rated pressure	MPa	0.8	
Protection anti-corrosion	—	Electronic anode	
Compressor	—	DC Inverter, frequency varies with hot water demand	
Fan	—	DC Inverter, 0~60Pa ⁽¹⁾ speed varies with ducts' length and hot water demand	
Defrosting	—	4-way-valve	
Throwing	—	Electronic expansion valve	

2.3.2 Electrical specifications

Model		GRS-1.5Pd/TD200ANpA-K	GRS-1.5Pd/TD270ANpA-K
Power supply	—	220-240V ~ 50/60Hz	
Rated input of heat pump	W	850	
Rated input of electrical heater	W	2000	
Max power input	W	2850	
Max operating current	A	12.4	
IP rating	—	IPX4	

2.3.3 Connections specifications

Model		GRS-1.5Pd/TD200ANpA-K	GRS-1.5Pd/TD270ANpA-K
Connections for the domestic hot water circuit	—	3/4" inside thread	
Air connections (inlet and outlet)	mm	160	

2.3.4 Specifications for the heat pump

Model		GRS-1.5Pd/TD200ANpA-K	GRS-1.5Pd/TD270ANpA-K
Heating capacity ⁽²⁾	W	1700	1700
Power input ⁽²⁾	W	425	425
COP ⁽²⁾	—	4.0	4.0
Refrigerant	Name		R290
	Charge	kg	0.15
GWP		—	3
CO ₂ equivalent		t	0.00045
Heat pump operating range		°C	-7~45
Maximum and minimum water operating temperatures		°C	35~70
Maximum and minimum water operating pressures		MPa	0.1~0.7

2.3.5 Performances—Average Climate 7/6°C

EN 16147:2017+A1:2022, Outdoor air heat pump (placed indoor side), 230V ~ 50Hz, 360m ³ /h, 30Pa ⁽¹⁾				
Model			GRS-1.5Pd/TD200ANpA-K	GRS-1.5Pd/TD270ANpA-K
Thermostat set point temperature	°C		54	52
Tapping load profile	—		XL	XL
Class	—		A+	A+
Coefficient of performance	COP _{DHW}	—	3.20	3.50
Water heating energy efficiency	η_{wh}	—	135%	145%
Maximum volume of mixed water at 40°C	V ₄₀	L	282	328
Reference hot water temperature	θ'_{WH}	°C	54.7	52.3
Heating up time	t _h	h:min	07:22	08:00
Heating up electrical energy consumption	W _{eh-HP}	kWh	3.000	3.600
Stand-by power input	P _{es}	W	37.50	30.50
Daily electrical energy consumption	Q _{elec}	kWh	5.900	5.400
Annual electrical energy consumption	AEC	kWh/a	1250	1150
Sound power level LWA	(outdoors/ indoors)	dB(A)	54/48	

2.3.6 Performances—Warmer Climate 14/13°C

EN 16147:2017+A1:2022, Outdoor air heat pump (placed indoor side), 230V ~ 50Hz, 360m ³ /h, 30Pa ⁽¹⁾				
Model			GRS-1.5Pd/TD200ANpA-K	GRS-1.5Pd/TD270ANpA-K
Thermostat set point temperature	°C		58	52
Tapping load profile	—		XL	XL
Coefficient of Performance	COP _{DHW}	—	3.50	3.90
Water heating energy efficiency	η_{wh}	—	147%	160%
Maximum volume of mixed water at 40°C	V ₄₀	L	305	328
Reference hot water temperature	θ'_{WH}	°C	58.2	52.3
Heating up time	t _h	h:min	06:40	07:30
Heating up electrical energy consumption	W _{eh-HP}	kWh	3.000	3.100
Stand-by power input	P _{es}	W	39.00	28.00
Daily electrical energy consumption	Q _{elec}	kWh	5.400	4.900
Annual electrical energy consumption	AEC	kWh/a	1140	1042

2.3.7 Performances—Colder Climate 2/1°C

EN 16147:2017+A1:2022, Outdoor air heat pump (placed indoor side), 230V ~ 50Hz, 360m ³ /h, 30Pa ⁽¹⁾				
Model			GRS-1.5Pd/TD200ANpA-K	GRS-1.5Pd/TD270ANpA-K
Thermostat set point temperature	°C		56	52
Tapping load profile	—		XL	XL
Coefficient of Performance	COP _{DHW}	—	2.90	2.90
Water heating energy efficiency	η_{wh}	—	120%	120%
Maximum volume of mixed water at 40°C	V ₄₀	L	280	328
Reference hot water temperature	θ'_{WH}	°C	56.2	52.3
Heating up time	t _h	h:min	08:10	09:50
Heating up electrical energy consumption	W _{eh-HP}	kWh	3.700	4.000
Stand-by power input	P _{es}	W	39.00	32.00
Daily electrical energy consumption	Q _{elec}	kWh	6.400	6.500
Annual electrical energy consumption	AEC	kWh/a	1360	1388

NOTES:

- ① The performance parameters in accordance with EN 16147:2017+A1:2022, (EU) No 814/2013.
- ② Noise (the sound power level) is measured according to EN 12102-2:2019.
- ③ The technical parameters test in a new unit with clean heat exchangers and in auto water heating mode.
- ④ ⁽¹⁾ Indicates that the adjustment parameters of E26 on the wired controller are different under different air outlet static pressures. See Section 5.3 for details.
- ⑤ ⁽²⁾ Indicates that the parameters obtained with the following conditions: Outdoor temperature: 14°CDB/13°CWB; Water tank temperature (start/end): 10°C/55°C; With no ducts.
- ⑥ Please always see the nameplate for the exact data as this table is subject to change.

2.4 Product Performance Curves

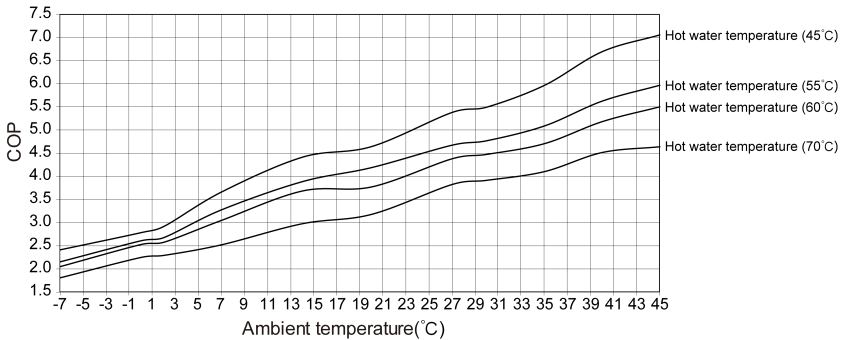

Fig.2.4-1 COP at different ambient temperatures when heating to different hot water target temperatures

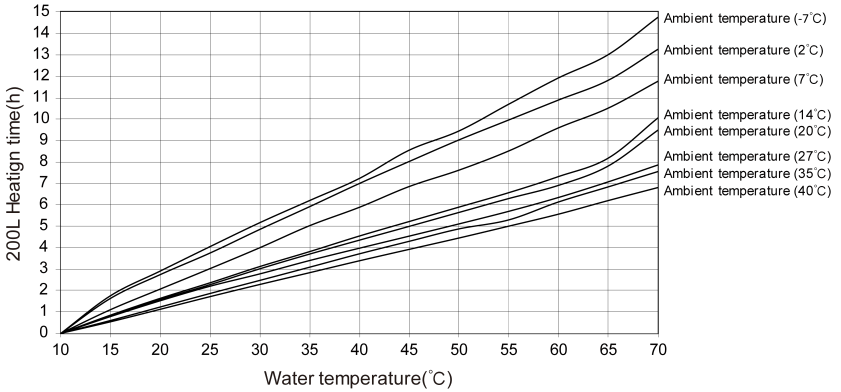

Fig. 2.4-2 GRS-1.5Pd/TD200ANpA-K heating time to different hot water target temperatures for different ambient temperatures

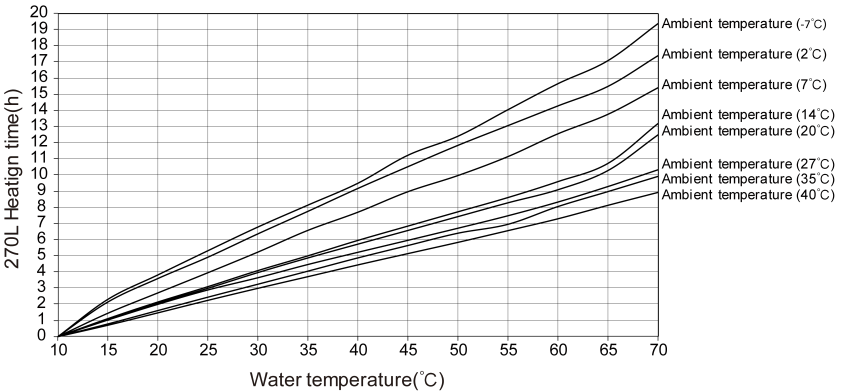
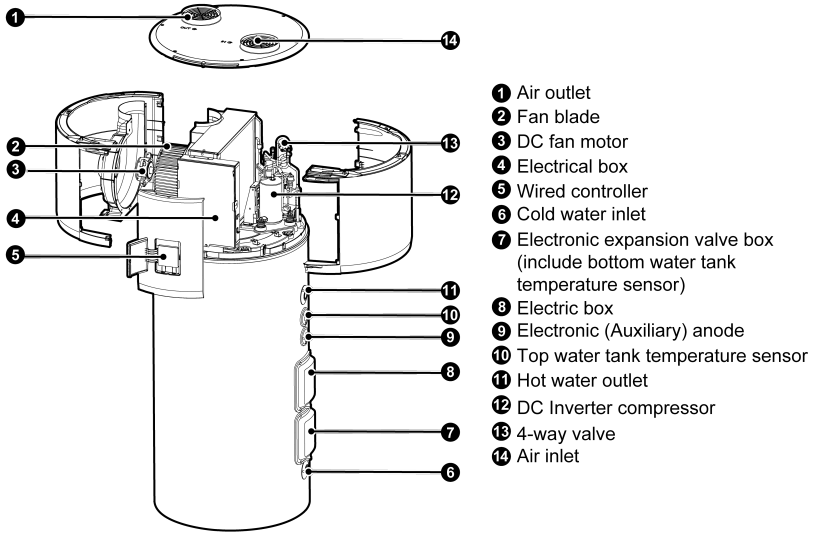

Fig. 2.4-3 GRS-1.5Pd/TD270ANpA-K heating time to different hot water target temperatures for different ambient temperatures

NOTES:

- ① The above curve data are fitted based on the test parameters of Gree Laboratory(The test conditions are: initial water temperature: 10°C, power supply: 230V ~ 50Hz; static pressure of air outlet: 30Pa; air volume: 360 m³/h; in a new unit with clean heat exchangers and in auto water heating mode). So there will be about 5% error and the curves are for reference only.
- ② In BOOST mode, the electrical heater and heat pump will be together started to heating. The heating rate of GRS-1.5Pd/TD200ANpA-K and GRS-1.5Pd/TD270ANpA-K is increased by about 7.9°C/h and 6°C/h respectively. On the other hand, COP will decrease and power consumption will increase.

2.5 Introduction of Parts



- ① Air outlet
- ② Fan blade
- ③ DC fan motor
- ④ Electrical box
- ⑤ Wired controller
- ⑥ Cold water inlet
- ⑦ Electronic expansion valve box (include bottom water tank temperature sensor)
- ⑧ Electric box
- ⑨ Electronic (Auxiliary) anode
- ⑩ Top water tank temperature sensor
- ⑪ Hot water outlet
- ⑫ DC Inverter compressor
- ⑬ 4-way valve
- ⑭ Air inlet

2.6 Accessories

For the standard accessories of the product, please refer to the actual. In the installation diagram, engineering consumables such as valves and pipes that are not equipped must be purchased separately according to actual requirements (e.g. thermostatic mixer tap, waterway filter, check valve, pressure regulation valve, cut-off valve, male threaded coupler, tee-junction, water pipe, mounting frame, self-temperature limitation heating belt, air pipes, etc.).

3 Before Installation

3.1 Unpacking

When unpacking ensures the following items are included:

Main Unit	The Main unit including the heat pump and storage tank (integral).
Safety valve	Pressure-relief device (May be pre-fitted)
Condensation Tube	Used for draining condensation from the unit
Owner's manual	In-depth installation & maintenance detail on the product
Owner's manual (Controller)	In-depth control descriptions detail on the product

3.2 Transporting

The following should be adhered to when transporting the unit:

- (1) Transport the product to the installation site using a fork-lift truck or pallet truck.
- (2) Don't incline the unit more than 25° from vertical when moving, and keep it vertical when installing.
- (3) Avoid scratching or damaging the unit by using protective coverings where applicable.
- (4) As this unit is heavy it needs to be carried by two or more persons, to avoid injury and/or damage.

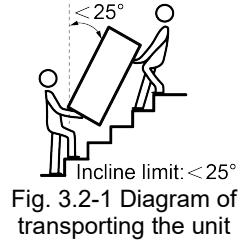

4 Installation of Product

4.1 Safety Notices for Installation, Maintenance and Relocation of Unit

- (1) Please read the instructions for use, installation and maintenance carefully before use.



- (2) If the product needs to be installed, moved or maintained, please contact our designated dealer or local service center for professional support. Users should not disassemble or maintain the unit by themselves, otherwise it may cause relative damage, and our company will bear no responsibilities.
- (3) During installation or relocation of the unit, the refrigerant circuit can't be mixed with the substances (such as air, other refrigerants, etc.) except the specified refrigerant, otherwise it will cause the system pressure to rise, and the compressor may burst and cause injury.
- (4) If the user use their own installation materials for installation, we may not be liable to bear relevant legal responsibilities for all the losses incurred by pipeline leaks, crashes, and poor installation that affect the normal operation and use of this product.
- (5) Avoid installation in a small room to prevent the refrigerant concentration in the room from exceeding the limit when the refrigerant leaks, which may cause hypoxia or suffocation.

4.2 Unit Installation Diagram

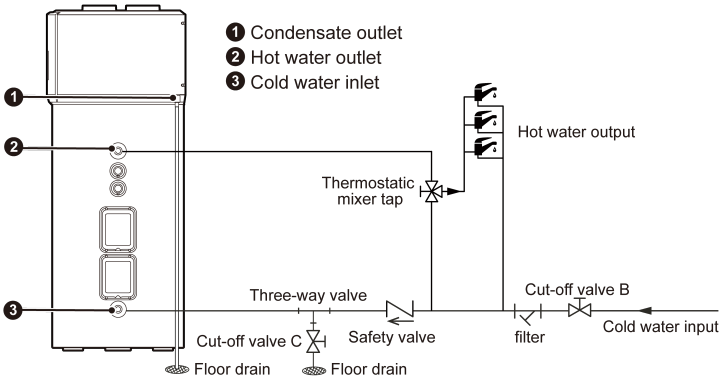

Fig. 4.2-1 Unit Installation Diagram



WARNING!

- To ensure water safety, Insulation plastic pipes such as PPR pipes are recommended to be used. The PPR pipe length at the water inlet and outlet is determined as per the formula: $L \geq 70 \times R^2$, wherein L indicate the pipe length, and R indicates the inner diameter of the pipe (unit: cm). The pipes should be insulated properly. No metal pipe is allowed.

4.3 Structural Dimension

Unit: mm

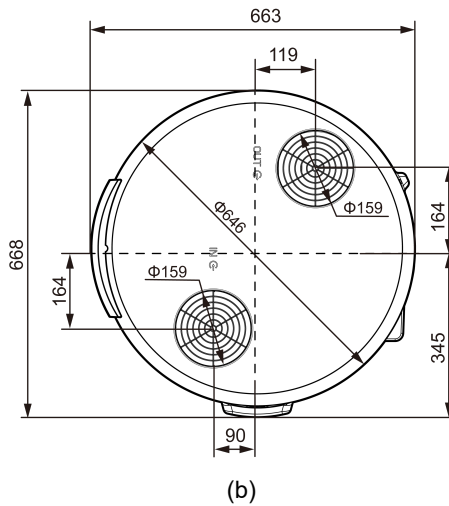
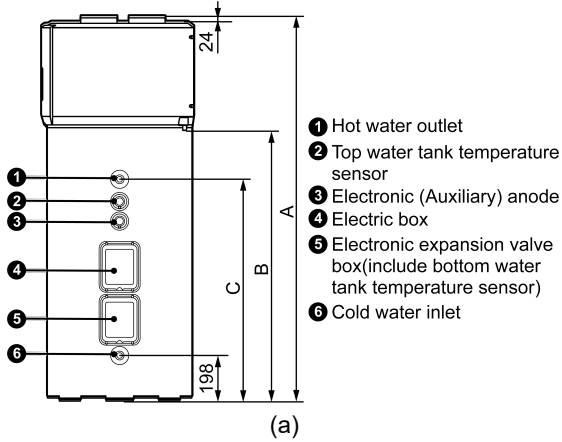

Parameter \ Model	GRS-1.5Pd/TD200ANpA-K	GRS-1.5Pd/TD270ANpA-K
A	1667	1947
B	1177	1459
C	964	1235

4.4 Requirements of Installation Dimension

Unit: mm

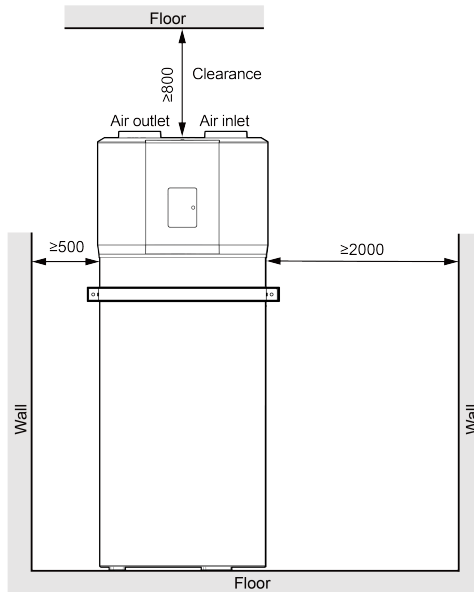

4.5 Installation Requirements

- (1) Ensure that the sound and airflow of the unit will not affect people, animals, or plants, etc.
- (2) Ensure that the unit has good ventilation. If a canopy is installed to protect the unit, it should be noted that heat dissipation and heat absorption shouldn't be affected.
- (3) The unit should be installed in a place with a solid foundation and make sure that the unit is installed upright. The impact of strong wind, typhoon and earthquake or other natural disasters should be fully considered, and the installation should be reinforced.
- (4) Ensure the reliable connection of the drain pipe of the unit and lead the drain pipe to a proper place for drainage.

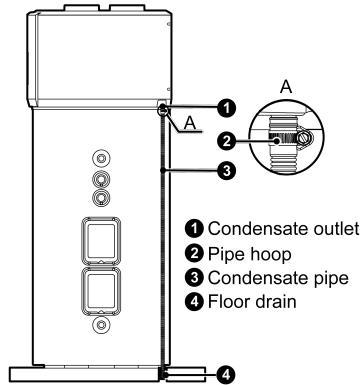

Fig. 4.5-1 Drainage Connection Diagram

- (5) The unit must be installed in a place with rain and sun shading devices where it can be sheltered from rain.
- (6) The unit and water system piping and valves should be installed as far as possible in the ambient temperature above 0°C, and preferably installed near the main hot water point.
- (7) In order to avoid inconvenience or property damage to user due to water leakage caused by improper connection of water pipe or normal water release of safety valve, it is forbidden to install the unit in a place without good drainage.
- (8) The unit shall be located upright. The installation ground must be flat and spacious, and the foundation shall be solid enough to bear four times of the weight of the unit after the unit being filled with water. It is strictly forbidden to hang the unit or hang it on an external wall. When installing the unit, it's necessary to use fixing belt to protect the unit. If the unit is installed in areas with strong winds, typhoons, or earthquakes, in addition to using fixing belt for installation, additional reinforcement measures must be taken to prevent the unit from tipping over under external forces, thus causing unnecessary unit damage or personal injury. The fixing belt of the unit only serves as an auxiliary fixation and cannot bear the weight of water tank.

4.6 Installation Requirements of Water System Pipeline

- (1) For water pipe, it is recommended to use the PPR pipe.
- (2) Each valve must be installed properly and the installation sequence must be consistent with the installation diagram of the unit.
- (3) The pipelines shall be laid centrally. Hot water outlet of the unit shall not be far from the place where the hot water is taken. There should be floor drain near the unit.
- (4) If the tap water contains impurities, a water filter must be installed.
- (5) The connecting parts of the water pipe must be sealed with tape to prevent water leakage.
- (6) All water system pipelines, valves and pipe joints, etc. must be insulated. It is recommended that the thickness of the insulation pipe is not less than 15mm.
- (7) When the installation environment temperature is below 0°C, the pipeline must be equipped with self-limiting temperature heater.
- (8) The pressure will gradually rise during the heating process of the water tank, and a small amount of water shall be discharged through the safety valve to relieve the pressure. If it is not installed or installed incorrectly, expansion, deformation or any other damage may occur to the unit, and even personal injury will be caused. It is forbidden to install a cut-off valve or check valve between the safety valve and the unit, otherwise the safety valve will not be able to relieve pressure. The safety valve must be connected to the drain hose and the connection must be reliable to prevent falling off; the drain hose shall be introduced into the floor drain naturally, and there cannot be bulges, entanglement, folding, etc. After connecting to the floor drain, the spare hose must be cut off so as not to cause poor drainage and the water in the hose will not be frozen in low temperature environment. The type of the safety valve is an external pressure relief valve. The discharge pipe connected to the safety valve (pressure-relief device) must be installed in a continuously downward direction and in a frost-free environment. And it is forbidden to block the exhaust hole of floor drain.

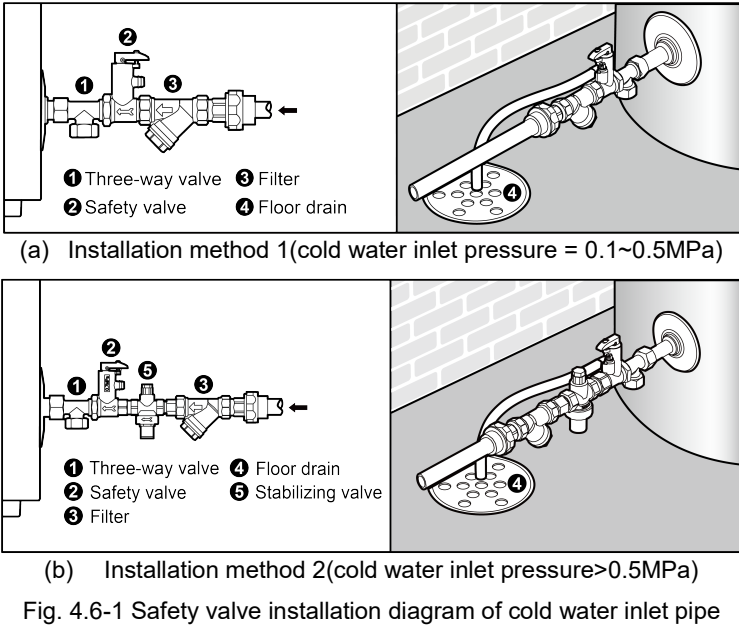

Fig. 4.6-1 Safety valve installation diagram of cold water inlet pipe

For installation method 2, add stabilizing valve, ensure that the entering pressure of water tank is between 0.3~0.5MPa. The arrow direction of the stabilizing valve must be consistent with that of water flow.

- (9) The water quality for the air source water heater should comply with the local sanitation standard for the domestic drinking water and refer to the following water quality requirements.

Table 4.6-1 Water Quality Requirements

pH (25°C)	6.8~8.0	Turbidity (scattering turbidity unit)/NTU	<1
Chloride/(mg/L)	<50	Iron/(mg/L)	<0.3
Sulfate/(mg/L)	<50	Silica (SiO ₂)/(mg/L)	<30
Total hardness (calculated in CaCO ₃)/(mg/L)	<70	Nitrate (calculated in N)/(mg/L)	<10
Conductivity (25°C)/(μ s/cm)	<300	Ammonia nitrogen (calculated in N)/(mg/L)	<1.0
Total alkalinity (calculated in CaCO ₃)/(mg/L)	<50	Sulfide/(mg/L)	Shall not to be detected

4.7 Installation Requirements for Pipeline of Wind System

This product can be equipped with two ventilation pipelines for indoor and outdoor ventilation. One pipeline is used to deliver outdoor fresh air into the room,

and the other pipeline is used to discharge the air of the unit to the outside. When the airflow flows through the pipeline, the pipeline will create a certain resistance to the airflow. The greater the resistance is, the smaller the ventilation volume. Besides, the wind resistance of pipeline will increase if the length of pipeline is too long, the diameter is too small, and there are too many bends, thus reducing the ventilation volume. Therefore, please follow the following recommended principles for installation and design:

- (1) The nominal static pressure of the unit is 30Pa and the maximum static pressure is 60Pa.
- (2) PVC pipe is recommended for air duct to reduce the resistance of wind system. Generally, the length of each ventilation pipeline shall not exceed 5m.
- (3) Minimize the use of elbow in pipeline. The number of elbow in each pipeline shall be controlled within $5m(A+C \leq 5m; B+D \leq 5m)$. The bending part of elbow should be designed as an arc to avoid 90° right angle bending.
- (4) The inner wall of pipeline is smooth, free from dust and wrinkles.
- (5) The difference in temperature between the air flowing through the pipe and the air in the installation room can cause condensation to form on the outside surface of the pipe. Insulation layers must be set on the outlet air duct, inlet (return) air duct and pipe joints to prevent heat leakage and condensation. The recommended thickness for insulation layer should not be less than 15mm. Glue the adhesive nails on the air duct, then attach the insulation cotton with a layer of tin foil paper, fix it with the adhesive nail cover, and finally seal the connection joint tightly with tin foil tape; other materials with good insulation effect can also be used for insulation.
- (6) The outlet and return air ducts should have iron brackets fixed on the prefabricated floor panels. Seal the air duct joints tightly with glue to prevent air leakage.
- (7) In order to prevent leak air from being extracted by recirculation, maintain a clearance (≥ 220 mm) between the ends of the air pipes.
- (8) The design and construction of air duct shall comply with relevant national and local engineering specifications.

- (9) The recommended distance between the edge of the return air duct and the wall is 150mm or more, and a filter screen needs to be added for the return air outlet.
- (10) The filter screen needs to be cleaned or replaced regularly. During design and installation, leave maintenance space at a side of air duct.
- (11) After installing the air duct or engineering filter screen, hands shall not touch the internal components.
- (12) The design and construction of air duct shall consider sound attenuation and vibration reduction. In addition, the noise source must avoid the crowds. Do not design the air vent above the user's head (in places such as office and rest area). If the users require the indoor noise to be as low as possible, just consider to connect duct silencers in series in the duct. There are many types of silencers, and please ask for professional guidance during selection. After installing a suitable silencer, the noise at the air outlet can be reduced.

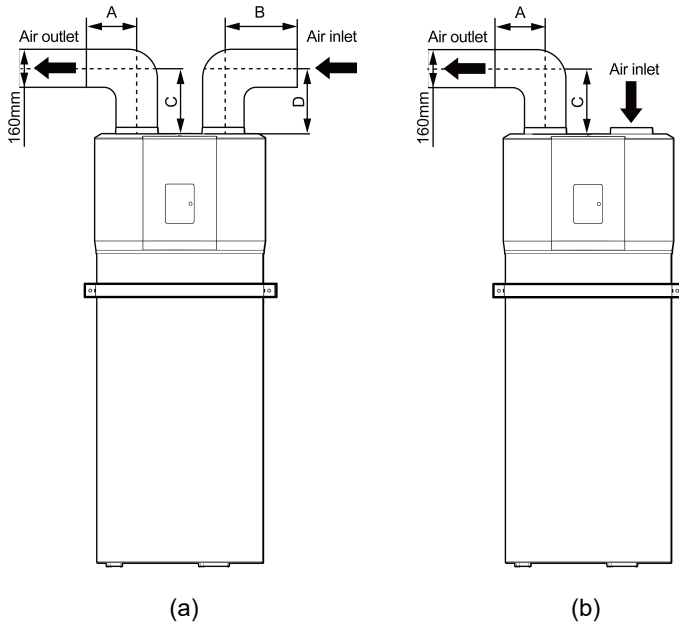

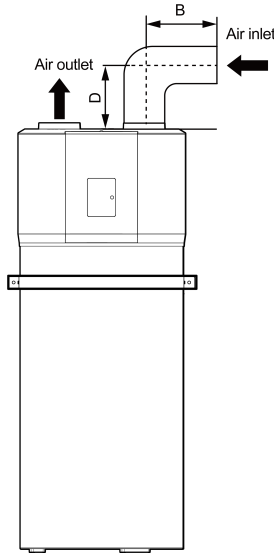

(c)
Fig. 4.7-1 Installation diagram of air inlet and outlet ducts

4.8 Electrical Installation



WARNING!

- The appliance shall be installed in accordance with national wiring regulations, and installation of the unit must be done by qualified personnel.
- The power supply must comply with the specifications on the nameplate. The carrying capacity of the power supply, wires and sockets should be confirmed before installation.
- The fixed circuit must be equipped with a residual current device (RCD) and a circuit breaker with sufficient capacity to ensure that all poles are disconnected from the power supply when necessary. The action time of the residual current device (RCD) should be less than 0.1s.
- The unit must be grounded reliably. The grounding wire should connect with special device of buildings.
- The unit circuit must be at least 1.5m away from any inflammable surface.
- Separate fixed device for power supply must be used, and its structure shall match the power supply of water heater, and comply with relevant national and local standards.
- Do not use socket converters, cable extension cords or wiring boards to accommodate the power cord of water heater, no switch to other power cords to accommodate family power. Connect wires for the water heater separately and do not share the same circuit with other electrical appliances.
- Please see the electrical schematic diagram for exact details.
- If the power cord is damaged, it must be replaced by the manufacturer, its service agent or similarly qualified persons in order to avoid a hazard. It is not allowed to reconnect the damaged power cord.

4.8.1 Selection of Power Cord Diameter and Circuit Breaker

Table 4.8-1 Unit Power Cord Configuration Table

Model	Power supply	Minimum sectional area (mm ²) of power cord			Circuit breaker (A)	Fuse capacity (A)
		L	N	PE		
GRS-1.5Pd/TD200ANpA-K	220-240V~ 50/60Hz	1.5	1.5	1.5	16	16
GRS-1.5Pd/TD270ANpA-K						

4.8.2 Wiring Diagram

- (1) The external wiring diagram of the unit is as follows. For the internal wiring diagram, please refer to the circuit diagram attached on the machine.
- (2) The following two installation methods can be used for the display board (wire controller).

If the wire controller needs to be installed in an indoor area other than the unit's panel, its wiring method should be in accordance with method I in the figure.

If the wire controller needs to be installed on the unit's panel, its wiring method should be in accordance with method II in the figure.

(Note: Connect according to either method I or method II)

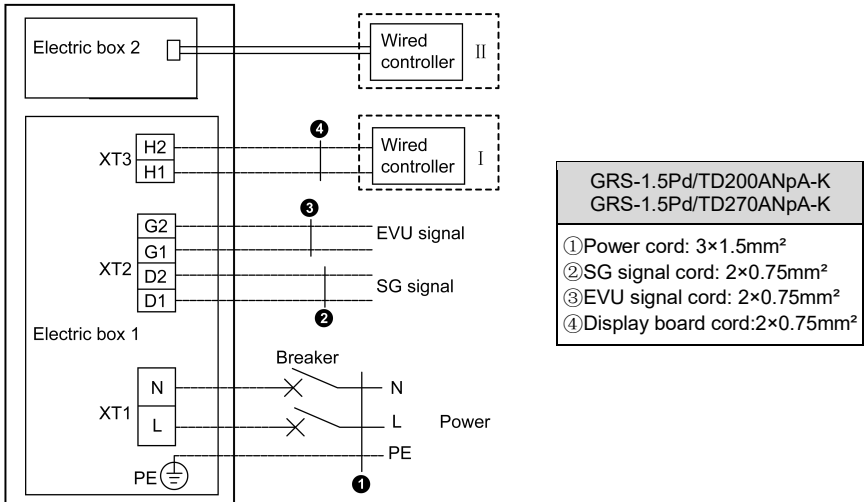

Fig.4.8-1 External wiring

4.8.3 Electrical Wiring and Connection Requirement

- (1) After completing wiring connection, the power cord and communication wires must be tightly pressed with a fixed wire clamp. The fixed wire clamp should be pressed on the outer sheath of the connection wire.

- (2) When arranging wiring connection for the external unit, the communication cord of wired controller shall be separated from the power cord. The minimum distance between the parallel wires shall be greater than 20cm. Otherwise, the communication of the unit might be abnormal. The strong and weak wires shall be covered separately with wire sleeves.

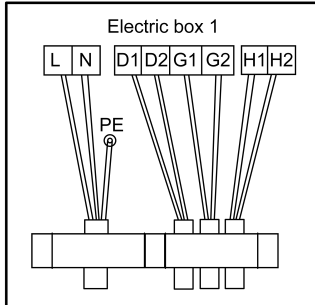

Fig.4.8-2 External wiring and fixing figure

4.9 Wired Controller Installation

The wire controller is installed on the front panel of the unit by default. When it needs to be adjusted to other places outside the unit, it is recommended that the length of the communication cable between the wired controller and the unit can't be more than 8m.

For detail installation method of wired controlled, please reference to the manual of the wired controller.

5 Commissioning Operation



WARNING!

- Safety measures must be taken for operation. All personnel involved in commissioning and maintenance must master the safety regulations of construction and implement them in strict accordance with the regulations.
- The electrician, welder and other special types of operators must get the permission for the corresponding post. When performing related operations on the equipment, the power supply of the whole unit must be cut off. Meanwhile, operate the unit in strict accordance with related safety requirements.
- All installation and maintenance operations must comply with the product design requirements and national and local safety operation requirements. Illegal operations are strictly prohibited.

5.1 Check before Commissioning

After the air source water heater is installed, be sure to check the unit according to the following table.

Table 5.1-1 Unit Installation Checklist

Items to be checked	What may happen if the installation is improper
Whether the unit is installed reliably	The operation of the unit produces noise or vibration, and even causes danger such as falling
Whether there are obstacles at the air outlet and air inlet of the unit	The unit operates abnormally
Whether the cold water inlet pipe and hot water outlet pipe use PPR pipes	Safety hazard may happen
Whether the safety valve of water tank is installed	The operation pressure of water tank is high and there may be safety hazard.
Whether a stabilizing valve is installed when the inlet pressure of water tank is too high	The operation pressure of water tank is high. The safety valve continuously discharges water and produces abnormal noise
Whether all parts of the water pipeline have been properly insulated	The performance of the unit may be affected and the pipeline may be damaged by freezing
Whether the power supply voltage is consistent with the product nameplate, and whether the wire type meets the regulations	The unit has malfunction or the parts are burned out

5.2 Trial Operation



NOTE!

- The water tank of the unit must be filled with water before the unit can be powered on.

The whole unit can be debugged only after the unit has passed the installation inspection. The debugging steps are as follows:











- (1) Water recharge of the unit: refer to the installation tips label on the water tank of the unit to perform water recharge. Ensure that there is no water leakage in the pipelines, joints, etc.
- (2) Energization of the whole unit: After the unit is energized, observe whether the display of wired controller is normal. If there is no fault, it is normal.
- (3) System time calibration of wired controller: set the time according to the manual of the wired controller.
- (4) Operation of the whole unit: turn on the unit with the wired controller. When the wired controller displays heating icon, check whether the unit is operating normally. Normal judgement criterion: the fan is running normally, the whole unit is running stably without obvious vibration and abnormal noise. The unit can be delivered to the user after running for at least 20 minutes without abnormality.

5.3 Debugging for Air Volume

The unit is developed based on the outlet air static pressure of 30Pa. If the resistance of air outlet is different, it will affect the air volume and performance of the unit. Therefore, during actual installation process, please pay attention to correct the resistance of air duct to maintain consistency between air volume and nominal value.

When the unit is installed, the air volume can be corrected by adjusting the engineering parameter E26 (compensation notch for fan speed) of the wired controller according to the actual situation.

(1) Setting method for E26 parameter value

- 1) Press “”+“” for 5 seconds, the temperature area will display “00”.
- 2) Press “”+“” for 5 seconds, the temperature area will display “E00”.
- 3) Press “” or “” to adjust “E00” to “E26”.
- 4) Press “” to switch to set parameter value, at this time, “01” in the clock area will flash.
- 5) Press “” or “” to adjust “01” to the required notch.
- 6) Press “” for confirmation and complete setting.

(2) Relationship of E26 parameter value, static pressure and fan speed

- 1) If adjusting E26 to 00, static pressure is 0Pa, the fan speed will change along with the operation parameter of the unit (The unit doesn't connect with air duct);
- 2) If adjusting E26 to 02, static pressure is 20Pa;
- 3) If adjusting E26 to 03, static pressure is 30Pa;
- 4) If adjusting E26 to 04, static pressure is 40Pa;
- 5) If adjusting E26 to 05, static pressure is 60Pa.



Fig.5.3-1 Display interface of E26

6 Maintenances

In the process of produce maintenance, please contact our designated dealer or local service center when maintaining or replacing related components.

6.1 Water Recharge, Drainage and Cleaning

The water recharge and drainage of the unit shall be followed up throughout the whole process to avoid water leakage accidents caused by wrong operation. Before the process of water recharge, drainage or cleaning, please turn off the power supply.

(1) Water recharge

- 1) Open the cold water inlet valve.
- 2) Fill the unit with water by opening the hot water outlet valve and a hot water tap.
- 3) Once water flows from the hot water tap, ensure all air in the system is bled then close the hot water tap.

(2) Water drainage

- 1) Close the cold water inlet valve & open a hot water tap.
- 2) Open the drainage pipe valve; drain out all the water in the inner tank.
- 3) Close the drainage pipe valve, re-fill the inner tank with water, and turn the power back on.

(3) Cleaning of water tank of the unit

Repeat the water drainage and recharge operations until the water discharged from the water tank of the unit is clear. Please clean the water tank periodically (every half year) to get good-quality water.

6.2 Maintenance of Anode Rod

The unit adopts electronic anode for corrosion prevention.

For the water tank of the unit with electronic anode, do not cut off the power after the unit is shut down, otherwise the electronic anode won't have the function of protecting the inner tank of the water tank. If the unit won't be used for a long time, it will inevitably need to cut off the power supply. Please be sure to drain the water in the water tank and pipeline!

6.3 Maintenance of Safety Valve

The safety valve handle should be opened regularly for inspection. It is recommended to check every six months.

If there is no water flowing out, it means that the safety valve is blocked. Please replace it with the same model of safety valve.

During heating operation, the water tank will discharge a small amount of water through the safety valve, which is a normal pressure relief phenomenon. However, if there is obvious large-flow drainage or even pipeline vibration, please apply for maintenance.

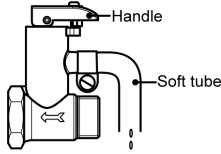

Fig. 6.3-1 Diagram of safety valve

6.4 Maintenance in Winter

When using this product in winter (the temperature may be lower than 0°C), please ensure that the unit is always energized. If the unit won't be used, make sure to drain the water in the water tank and pipeline of the unit to avoid freezing and cracking of the system.

7 Common Phenomena

Phenomenon	Cause
The displayed water temperature decreases significantly but hot water is still available.	The temperature sensor that shows the water temperature is located in the middle-upper part of the tank and only senses the local hot water temperature at this location. In the process of using water, when the displayed water temperature decreases, the part of the water tank higher than the position of this sensor can still release hot water with temperature higher than the current displayed water temperature, about 1/5 to 1/3 of the water tank.
The displayed water volume decreases significantly but hot water is still available.	The unit estimates the hot water volume through the temperature of the two temperature sensors in the middle-upper part and middle-lower part of the water tank. It is a rough judgment, and the water volume display bar is for reference only. In the process of using water, when the water quantity display bar changes from one bar to empty, there is a certain amount of hot water available in the tank, about 1/5 to 1/3 of the water tank.

Phenomenon	Cause
The displayed water temperature decreases significantly but the unit doesn't operate	<p>Please check whether the timer or preset function is enabled. With this function, the unit only operates within the set time range. If the function is enabled, please calibrate whether the system time and function opening time are accurate, or cancel this function;</p> <p>Please check whether the "Sunflower" energy-saving heating function is enabled. This function only produces hot water in the period with high ambient temperature every day to achieve energy saving purposes. If it cannot meet your needs and habits, please cancel this function;</p> <p>Please check whether the "Holiday" functions are enabled.</p> <p>The above functions can be cancelled by setting the wired controller or restoring the factory settings.</p>
The unit is often turned on for heating	In actual use, the hot water is in the middle-upper part of the water tank and the cold water is in the middle-lower part of the water tank. The unit will automatically judge to start heating according to the cold water temperature in the middle-lower part, which is not related to the displayed water temperature value. The times that the unit starts heating will not lead to a significant difference in energy consumption, and the hot water is stored in the water tank.
The volume of hot water decreases in winter	The hot water stored in the water tank will not actually reduce, but because of the low temperature of tap water in winter, more hot water in the tank needs to be consumed when bathing. It is recommended to appropriately increase the set water temperature or go bathing in turns with suitable intervals.
Water heating time is long	The unit is a storage type water heater equipped with a large water tank volume, and it takes a certain time to heat a whole tank of water. Water heating time in winter is longer than that in summer, it is recommended to heat water in advance or keep the unit on all day for use.
The unit is frosting.	The ambient temperature is low and frosting is a normal operation process. The unit will defrost regularly to ensure reliable operation.
Condensate flows out from the unit.	It is a normal phenomenon when the unit is running.
A small amount of water is discharged from the safety valve.	During heating operation, the water tank will discharge a small amount of water through the safety valve to relieve the pressure. This is a normal phenomenon.
After-sales Service	
The list of common fault codes can be found in the manual of the wired controller. If the product you purchased has a quality problem or a fault is displayed on the wired controller or other conditions shall be solved, please contact our designated dealer or local service center in time.	

8 Detailed Installation Instructions for Unit Fixing Belt

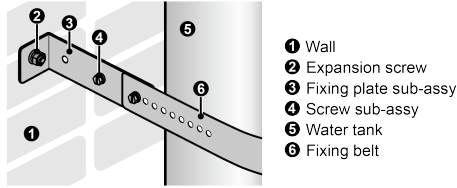

Fig. 8-1 Introduction to Related Parts of Fixing Belt

Table 8-1 Detailed Operation of Installing Fixing Belt

<p>Step 1: Confirm the installation location of the fixing belt. The installation height H of the expansion screw can be appropriately increased or decreased according to actual needs, but it must be ensured that the fixing belt cannot press against the gaskets at each pipe port of the water tank of the unit during installation.</p> <p>Step 2: Install expansion screws. Install the expansion screws on the wall.</p>	<p>Step 3: Install the fixing belt. Install one end of the fixing belt on one of the fixing plate sub-assy.</p> <p>Step 4: Install the fixing plate sub-assy. Install the two sets of fixing plate sub-assy on the expansion screws respectively.</p>	<p>Step 5: Fix the unit. Move the unit to the fixing plate sub-assy, select the appropriate connection holes on the fixing belt according to the actual installation situation, and use the screw sub-assy to complete the fixing.</p>

9 Detailed Maintenance Instructions for Refrigeration System

9.1 Safety Notices for Refrigeration System Reparation



- Appliance filled with flammable gas R290. Before repair the appliance, read the service manual first and in strict accordance with the requirement of manufacturer.
- This chapter mainly focuses on the special maintenance requirements of appliances using R290 refrigerant. For detailed maintenance operations, refer to the after-sales technical service manual.

9.2 Aptitude Requirement for Maintenance Man (Repairs should be done only be specialists).

- (1) Any person who is involved with working on or breaking into a refrigerant circuit should hold a current valid certificate from an industry-accredited assessment authority, which authorises their competence to handle refrigerants safely in accordance with an industry recognised assessment specification.
- (2) Servicing shall only be performed as recommended by the equipment manufacturer. Maintenance and repair requiring the assistance of other skilled personnel shall be carried out under the supervision of the person competent in the use of flammable refrigerants.

9.3 Safety Preparation Work

Prior to beginning work on systems containing flammable refrigerants, safety checks are necessary to ensure that the risk of ignition is minimised. For repair to the refrigerating system, the following precautions shall be complied with prior to conducting work on the system.

9.3.1 Work procedure

Work shall be undertaken under a controlled procedure so as to minimise the risk of a flammable gas or vapour being present while the work is being performed.

9.3.2 General work area

All maintenance staff and others working in the local area shall be instructed on the nature of work being carried out. Work in confined spaces shall be avoided. The area around the workspace shall be sectioned off. Ensure that the conditions within the area have been made safe by control of flammable material

9.3.3 Checking for presence of refrigerant

The area shall be checked with an appropriate refrigerant detector prior to and during work, to ensure the technician is aware of potentially toxic or flammable atmospheres. Ensure that the leak detection equipment being used is suitable for use with all applicable refrigerants, i.e. non-sparking, adequately sealed or intrinsically safe.

9.3.4 Presence of fire extinguisher

If any hot work is to be conducted on the refrigeration equipment or any associated parts, appropriate fire extinguishing equipment shall be available to hand. Have a dry powder or CO₂ fire extinguisher adjacent to the charging area.

9.3.5 No ignition sources

No person carrying out work in relation to a refrigeration system which involves exposing any pipe work shall use any sources of ignition in such a manner that it may lead to the risk of fire or explosion. All possible ignition sources, including cigarette smoking, should be kept sufficiently far away from the site of installation, repairing, removing and disposal, during which refrigerant can possibly be released to the surrounding space. Prior to work taking place, the area around the equipment is to be surveyed to make sure that there are no flammable hazards or ignition risks. "No Smoking" signs shall be displayed.

9.3.6 Ventilated area

Ensure that the area is in the open or that it is adequately ventilated before breaking into the system or conducting any hot work. A degree of ventilation shall continue during the period that the work is carried out. The ventilation should safely disperse any released refrigerant and preferably expel it externally into the atmosphere.

9.3.7 Checks to the refrigeration equipment

Where electrical components are being changed, they shall be fit for the purpose and to the correct specification. At all times the manufacturer's maintenance and service guidelines shall be followed. If in doubt, consult the manufacturers' technical department for assistance.

The following checks shall be applied to installations using flammable refrigerants:

- (1) The refrigerant name and its rated charge must be accurately filled in accordance with the unit nameplate, and the maximum charge amount cannot exceed 152g.
- (2) The ventilation machinery and outlets are operating adequately and are not obstructed.
- (3) If an indirect refrigerating circuit is being used, the secondary circuit shall be checked for the presence of refrigerant.

- (4) Marking to the equipment continues to be visible and legible. Markings and signs that are illegible shall be corrected.
- (5) Refrigeration pipe or components are installed in a position where they are unlikely to be exposed to any substance which may corrode refrigerant containing components, unless the components are constructed of materials which are inherently resistant to being corroded or are suitably protected against being so corroded.

9.3.8 Checks to electrical devices

Repair and maintenance to electrical components shall include initial safety checks and component inspection procedures. If a fault exists that could compromise safety, then no electrical supply shall be connected to the circuit until it is satisfactorily dealt with. If the fault cannot be corrected immediately but it is necessary to continue operation, an adequate temporary solution shall be used. This shall be reported to the owner of the equipment so all parties are advised.

Initial safety checks shall include:

- (1) That capacitors are discharged: this shall be done in a safe manner to avoid possibility of sparking;
- (2) That no live electrical components and wiring are exposed while charging, recovering or purging the system;
- (3) That there is continuity of earth bonding.

9.3.9 Repairs to sealed components

During repairs to sealed components, all electrical supplies shall be disconnected from the equipment being worked upon prior to any removal of sealed covers, etc. If it is absolutely necessary to have an electrical supply to equipment during servicing, then a permanently operating form of leak detection shall be located at the most critical point to warn of a potentially hazardous situation.

Particular attention shall be paid to the following to ensure that by working on electrical components, the casing is not altered in such a way that the level of protection is affected. This shall include damage to cables, excessive number of connections, terminals not made to original specification, damage to seals, incorrect fitting of glands, etc.

- (1) Ensure that the apparatus is mounted securely.

(2) Ensure that seals or sealing materials have not degraded to the point that they no longer serve the purpose of preventing the ingress of flammable atmospheres. Replacement parts shall be in accordance with the manufacturer's specifications.

Note: The use of silicon sealant can inhibit the effectiveness of some types of leak detection equipment. Intrinsically safe components do not have to be isolated prior to working on them.

9.3.10 Repair to intrinsically safe components

Do not apply any permanent inductive or capacitance loads to the circuit without ensuring that this will not exceed the permissible voltage and current permitted for the equipment in use.

Intrinsically safe components are the only types that can be worked on while live in the presence of a flammable atmosphere. The test apparatus shall be at the correct rating.

Replace components only with parts specified by the manufacturer. Other parts may result in the ignition of refrigerant in the atmosphere from a leak.

9.3.11 Cabling

Check that cabling will not be subject to wear, corrosion, excessive pressure, vibration, sharp edges or any other adverse environmental effects. The check shall also take into account the effects of aging or continual vibration from sources such as compressors or fans.

9.3.12 Detection of flammable refrigerants

Under no circumstances shall potential sources of ignition be used in the searching for or detection of refrigerant leaks. A halide torch (or any other detector using a naked flame) shall not be used.

9.3.13 Leak detection methods

The following leak detection methods are deemed acceptable for all refrigerant systems.

Electronic leak detectors may be used to detect refrigerant leaks but, in the case of flammable refrigerants, the sensitivity may not be adequate, or may need recalibration. (Detection equipment shall be calibrated in a refrigerant-free area.) Ensure that the detector is not a potential source of ignition and is suitable for the refrigerant used. Leak detection equipment shall be set at a percentage of the LFL

of the refrigerant and shall be calibrated to the refrigerant employed, and the appropriate percentage of gas (25% maximum) is confirmed.

Leak detection fluids are suitable for use with most refrigerants but the use of detergents containing chlorine shall be avoided as the chlorine may react with the refrigerant and corrode the copper pipe work.

If a leak is suspected, all naked flames shall be removed/extinguished.

If a leakage of refrigerant is found which requires brazing, all of the refrigerant shall be recovered from the system, or isolated (by means of shut off valves) in a part of the system remote from the leak. For appliances containing flammable refrigerants, oxygen free nitrogen (OFN) shall then be purged through the system both before and during the brazing process.

9.3.14 Removal and evacuation

When breaking into the refrigerant circuit to make repairs or for any other purpose conventional procedures shall be used. However, for flammable refrigerants it is important that best practice is followed since flammability is a consideration. The following procedure shall be adhered to:

- (1) remove refrigerant;
- (2) purge the circuit with inert gas; evacuate;
- (3) purge again with inert gas;
- (4) open the circuit by cutting or brazing

The refrigerant charge shall be recovered into the correct recovery cylinders. For appliances containing flammable refrigerants, the system shall be “flushed” with OFN to render the unit safe. This process may need to be repeated several times. Compressed air or oxygen shall not be used for purging refrigerant systems.

For appliances containing flammable refrigerants, flushing shall be achieved by breaking the vacuum in the system with OFN and continuing to fill until the working pressure is achieved, then venting to atmosphere, and finally pulling down to a vacuum. This process shall be repeated until no refrigerant is within the system. When the final OFN charge is used, the system shall be vented down to atmospheric pressure to enable work to take place. This operation is absolutely vital if brazing operations on the pipework are to take place.

Ensure that the outlet for the vacuum pump is not close to any ignition sources and that ventilation is available.

9.3.15 Charging procedures

In addition to conventional charging procedures, the following requirements shall be followed.

- (1) Ensure that contamination of different refrigerants does not occur when using charging equipment. Hoses or lines shall be as short as possible to minimise the amount of refrigerant contained in them.
- (2) Cylinders shall be kept upright.
- (3) Ensure that the refrigeration system is earthed prior to charging the system with refrigerant.
- (4) Label the system when charging is complete (if not already).
- (5) Extreme care shall be taken not to overfill the refrigeration system.

Prior to recharging the system, it shall be pressure tested with the appropriate purging gas.

The system shall be leak tested on completion of charging but prior to commissioning. A follow up leak test shall be carried out prior to leaving the site.

9.3.16 Decommissioning

Before carrying out this procedure, it is essential that the technician is completely familiar with the equipment and all its detail. It is recommended good practice that all refrigerants are recovered safely. Prior to the task being carried out, an oil and refrigerant sample shall be taken in case analysis is required prior to reuse of reclaimed refrigerant. It is essential that electrical power is available before the task is commenced.

- (1) Become familiar with the equipment and its operation.
- (2) Isolate system electrically.
- (3) Before attempting the procedure, ensure that:
 - (4) Mechanical handling equipment is available, if required, for handling refrigerant cylinders;
 - (5) All personal protective equipment is available and being used correctly;
 - (6) The recovery process is supervised at all times by a competent person;
 - (7) Recovery equipment and cylinders conform to the appropriate standards.
- (8) Pump down refrigerant system, if possible.
- (9) If a vacuum is not possible, make a manifold so that refrigerant can be removed from various parts of the system.
- (10) Make sure that cylinder is situated on the scales before recovery takes place.
- (11) Start the recovery machine and operate in accordance with manufacturer's instructions.

- (12) Do not overfill cylinders. (No more than 80% volume liquid charge).
- (13) Do not exceed the maximum working pressure of the cylinder, even temporarily.
- (14) When the cylinders have been filled correctly and the process completed, make sure that the cylinders and the equipment are removed from site promptly and all isolation valves on the equipment are closed off.
- (15) Recovered refrigerant shall not be charged into another refrigeration system unless it has been cleaned and checked.

9.3.17 Labelling

Equipment shall be labelled stating that it has been decommissioned and emptied of refrigerant. The label shall be dated and signed. For appliances containing flammable refrigerants, ensure that there are labels on the equipment stating the equipment contains flammable refrigerant.

9.3.18 Recovery

When removing refrigerant from a system, either for servicing or decommissioning, it is recommended good practice that all refrigerants are removed safely.

When transferring refrigerant into cylinders, ensure that only appropriate refrigerant recovery cylinders are employed. Ensure that the correct number of cylinders for holding the total system charge are available. All cylinders to be used are designated for the recovered refrigerant and labelled for that refrigerant (i.e. special cylinders for the recovery of refrigerant). Cylinders shall be complete with pressure-relief valve and associated shut-off valves in good working order. Empty recovery cylinders are evacuated and, if possible, cooled before recovery occurs.

The recovery equipment shall be in good working order with a set of instructions concerning the equipment that is at hand and shall be suitable for the recovery of all appropriate refrigerants including, when applicable, flammable refrigerants. In addition, a set of calibrated weighing scales shall be available and in good working order. Hoses shall be complete with leak-free disconnect couplings and in good condition. Before using the recovery machine, check that it is in satisfactory working order, has been properly maintained and that any associated electrical components are sealed to prevent ignition in the event of a refrigerant release. Consult manufacturer if in doubt.

The recovered refrigerant shall be returned to the refrigerant supplier in the correct recovery cylinder, and the relevant waste transfer note arranged. Do not mix refrigerants in recovery units and especially not in cylinders.

If compressors or compressor oils are to be removed, ensure that they have been evacuated to an acceptable level to make certain that flammable refrigerant does not remain within the lubricant. The evacuation process shall be carried out prior to returning the compressor to the suppliers. Only electric heating to the compressor body shall be employed to accelerate this process. When oil is drained from a system, it shall be carried out safely.

10 Troubleshooting

Error code	Error name	Possible causes	Solution
E1	System high pressure protection	The temperature sensor of water tank of the unit is not inserted in place; The unit is not filled with water; The wire of pressure switch is loose; The charged refrigerant is too excessive; The pressure switch is faulted; The main board is faulted; The heat exchange of water tank of the unit is abnormal; There is too much dirt in the water tank of the unit and the water tank needs to be cleaned.	It will recover by re-energization after troubleshooting.
E4	High discharge temperature protection	The resistance of exhaust temperature sensor is abnormal; Refrigerant of the unit leaks or the refrigerant is insufficient.	
E6	Communication error	The communication wire is loose or damaged; The display board is faulted; The mainboard is faulted.	It will recover automatically after troubleshooting.
F3	Outdoor ambient temperature sensor error	The temperature sensor is damaged; The mainboard is faulted.	
F4	Gas discharge temperature sensor error		
F6	Tube temperature sensor error		
Fd	Suction temperature sensor error		
FE	Top water tank temperature sensor error		
FL	Bottom water tank temperature sensor error		

Error code	Error name	Possible causes	Solution
U7	Abnormal reversing of 4-way valve	The temperature sensors of the water tank are normal; Reversing of 4-way valve is abnormal; Refrigerant of the unit leaks or the refrigerant is insufficient.	It will recover by re-energization after troubleshooting.
C5	Jumper cap error	The jumper cap is wrong; The jumper is poorly connected.	

Attachment: Error information table

Appendix table 1-1 Common error information

Error code	Error name	Error code	Error name
E1	System high-pressure protection	F4	Gas discharge temperature sensor error
E3	System less refrigerant protection/ low-pressure protection	Fd	Suction temperature sensor error
E4	High discharge temperature protection	F6	Tube temperature sensor error
E5	Compressor overload protection	d5	Temperature sensor error of return pipe
E6	Communication error	FL	Bottom water tank temperature sensor error
E7	Communication error of backwater plate	FE	Top water tank temperature sensor error
C5	Jumper cap error	EF	Blockage protection for air inlet or air outlet
L7	Water flow (water pressure) switch error	d8	Temperature sensor error of water outlet of casing
E0	Water pump error protection (semi-direct heat type)	L6	Insufficient capacity, anti-high ambient temperature operation or operation protection for long period
U7	Abnormal reversing of 4-way valve or insufficient refrigerant	bH	Temperature sensor error of return pump
F3	Outdoor ambient temperature sensor error	—	—

Appendix table 1-2 Drive error information

Error code	Error name	Error code	Error name
EE	EPROM storage chip error	AA	Inverter outdoor fan AC protection (input side)
ee	Inverter compressor driver storage chip error	AC	Inverter outdoor fan startup failure
H5	Inverter compressor driver IPM module protection	Ad	Inverter outdoor fan less phase protection

Error code	Error name	Error code	Error name
HC	Inverter compressor driver PFC protection	AE	Inverter outdoor fan driver current detecting circuit error
H7	Inverter compressor out-of-step protection	Ar	Inverter outdoor fan driver electric box temperature sensor error
Lc	Inverter compressor startup failure	AL	Inverter outdoor fan driver DC bus low-voltage protection or voltage drop error
Ld	Inverter compressor default phase protection	AJ	Inverter outdoor fan out-of-step protection
LF	Inverter compressor power protection	AH	Inverter outdoor fan driver DC bus high-voltage protection
PA	Inverter compressor driver AC protection (input side)	AP	Inverter outdoor fan driver AC input voltage error protection
Pc	Inverter compressor driver current detecting circuit error	AU	Inverter outdoor fan driver charging loop error
PF	Inverter compressor driver electric box temperature sensor error	A0	Inverter outdoor fan driver module reset
PH	High voltage protection for drive DC bus of inverter compressor	A1	Drive IPM module protection for inverter outdoor fan
PL	Inverter compressor driver DC bus low voltage protection or voltage drop error	A6	Master controller and inverter outdoor fan driver communication error
PP	Inverter compressor driver AC input voltage error protection	A8	Inverter outdoor fan driver module high-temperature protection
PU	Inverter compressor driver charging loop error	A9	Inverter outdoor fan driver module temperature sensor error
P0	Inverter compressor driver module reset	U9	Inverter outdoor fan driver AC input zero-sequence overcurrent protection
P5	Inverter compressor overcurrent protection	An	Inverter outdoor fan driver storage chip error
P6	Master controller and inverter compressor driver communication error	AF	Inverter outdoor fan driver PFC protection
P7	Inverter compressor driver module temperature sensor error	UL	Inverter outdoor fan overcurrent protection
P8	Inverter compressor driver module high-temperature protection	UP	Power protection for inverter fan
P9	Inverter compressor driver AC input zero-sequence overcurrent protection	—	—

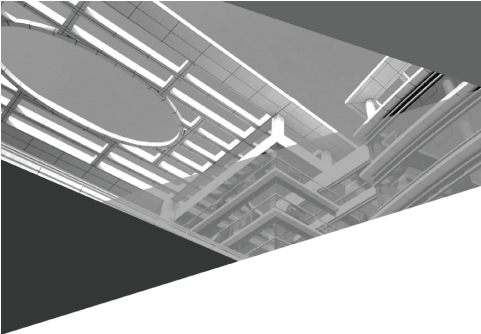

GREE ELECTRIC APPLIANCES, INC. OF ZHUHAI

Add: West Jinji Rd, Qianshan, Zhuhai, Guangdong, China, 519070

Tel: (+86-756) 8522218

Fax: (+86-756) 8669426

E-mail: global@cn.gree.com www.gree.com



600005067850